

---

# Severely Exposed Brickwork

**Technical Guide**  
Last Updated: April 2023



# The Brick Development Association

The Brick Development Association is the national authority on clay bricks and pavers.

The membership accounts for almost 99% of the bricks produced in the UK; the BDA members are committed to manufacturing products of outstanding quality and developing one of the nation's most productive and sustainable supply chains.

The BDA Guides and Technical Guides are continually updated to take account of the latest materials, systems and products developed in the clay brick and paver sector.

We are grateful to our various team of experts, contributors, staff as well as our membership whose support, we are eternally grateful for.

Keith Aldis

Chief Executive Officer  
Brick Development Association

## Scope of Document

This is an initial guidance document for the general public and members of the construction profession.

This document is aimed at all those in the delivery chain to help them achieve long lasting results when considering external works such as freestanding garden and retaining walls and chimneys which should always be considered as very severely exposed to frost attack regardless of geographic location.

Published by the Brick Development Association.(BDA).  
The BDA are committed to providing impartial and authoritative information. We make every effort to ensure the accuracy and quality of information and guidance when it is published. However we can take no responsibility for the subsequent use of this information, nor for any errors or omissions it may contain.

# UK Brick Manufacturers



## Bulmer

[www.bulmerbrickandtile.co.uk](http://www.bulmerbrickandtile.co.uk)

Sudbury (7)

## Forterra

[www.forterra.co.uk](http://www.forterra.co.uk)

Accrington (1), Claughton Manor (13), Cradley (14), Desford (16), Howley Park (24), Kirton (27), Measham (31), Whittlesey (47), Wilnecote (49)

## H.G. Matthews

[www.hgmatthews.com](http://www.hgmatthews.com)

Bellingdon (23)

## Ibstock

[www.ibstockbrick.co.uk](http://www.ibstockbrick.co.uk)

Aldridge & Atlas (2,3), Ashdown (4), Cattybrook (9), Chailey (10), Chesterton (12), Dorket Head (17), Ellistown (18), Eclipse (19), Laybrook (28), Lodge Lane (29), Parkhouse (34), Ravenhead (36), South Holmwood (39), Swanage (41), Throckley (42), Union (44)

## Ketley

[www.ketley-brick.co.uk](http://www.ketley-brick.co.uk)

Brierley Hill (25)

## Matclad

[www.matclad.co.uk](http://www.matclad.co.uk)

Wreham (30)

## Michelmersh

[www.mbhplc.co.uk](http://www.mbhplc.co.uk)

Michelmersh (32), Blockleys (6), Charnwood (11), Carlton (8), Freshfield (21)

## Northcot

[www.northcotbrick.co.uk](http://www.northcotbrick.co.uk)

Blockley (33)

## Raeburn

[www.raeburnbrick.co.uk](http://www.raeburnbrick.co.uk)

Blantyne (35)

## Sussex Handmade Brick

[www.sussexhandmadebrick.co.uk](http://www.sussexhandmadebrick.co.uk)

Sussex Handmade Brick (40)

## W.H Collier

[www.whcollier.co.uk](http://www.whcollier.co.uk)

Marks Tey (48)

## Wienerberger

[www.wienerberger.co.uk](http://www.wienerberger.co.uk)

Denton (15), Ewhurst (20), Hartleybury (22), Kingsbury (26), Sandown (37), Smeed Dean (38), Todhills (43), Waresley (45), Warnham (46)

## York Handmade

[www.yorkhandmade.co.uk](http://www.yorkhandmade.co.uk)

Alne (50)

# Contents

Introduction	5
Mortar	6
Movement Joints	7
Simple Freestanding Walls	8
Simple Retaining Walls	9
Chimney Construction	13
Window Cills	15
Step Flank Walls	16

# Introduction

## Severely Exposed Brickwork

Brick walls are attractive and durable when designed correctly and built with appropriate materials in a technically competent way.

Whilst consideration of geographical exposure is important when designing the walls of buildings (e.g. see the rainfall and frost exposure maps provided by the National House-Building Council (NHBC) it is recommended that all external works be classified as severely exposed to the risk of frost attack and be designed and built accordingly.

Paving applications are not covered in this note as BS EN 771-1 bricks are not intended for these uses. Clay pavers to BS EN 1344 are available.

This BDA guidance has been produced to bring together information issued in separate documents in the past with members' recent experience. There is some evidence to suggest changing climatic conditions over the last few winters i.e. wetter spells preceding severe overnight temperature falls, and this document takes account of this.

## Exposure Zones

The UK is divided into zones where long-term studies have shown likely levels of rainfall. This exposure map is important when designing structures and what considerations should be made on choice of materials.

Much of Scotland, Wales and South West England down to Cornwall will be affected by more severe weather conditions than the rest of Britain, and the following guide is aimed at ensuring brickwork remains pristine and durable by using the correct materials and appropriate design.

The map illustrated gives a general view of areas of exposure to wind driven rain. Local knowledge and terrain may prove areas on the map marked as moderate or sheltered are in fact subject to severe conditions where design and detailing of structures should reflect a protective approach.

**It is strongly recommended that the Brick Manufacturer is consulted at the design stage for the applications covered by this guidance.**





# Mortar

Mortar goes hand in hand with brick and is an extremely important part of the specification.

## Mortar Strength

The Mortars generally used in the walls of buildings, e.g. 1:1:6 cement/lime/sand or 1:6 plus plasticizer, when used in exposed detailing, such as chimneys, cills, plinths, boundary walling and below DPC, on exposed sites are at risk of suffering frost attack.

Once mortar deteriorates it will compromise the rest of the brickwork.

Incorrect batching and mixing could ruin brickwork, so extreme care must be taken when mixing on site.

## Mortar joint Profiles

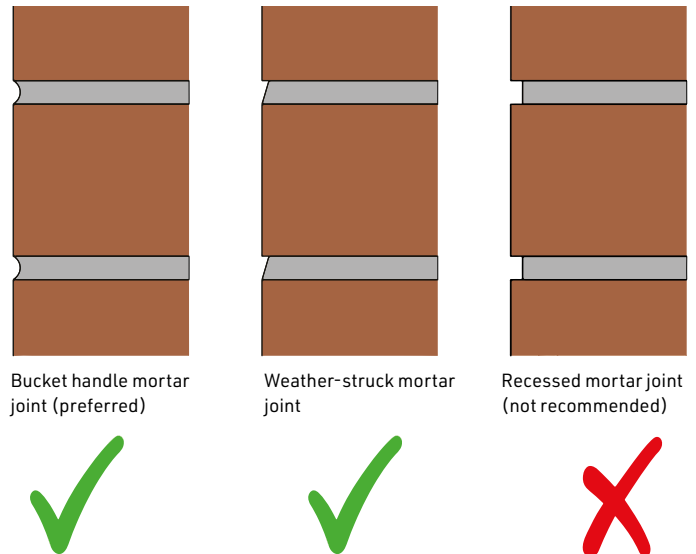

## Mortar Strength and Exposed Brickwork

The table below shows the constituents of the recognised designations when detailing severely exposed brickwork

Designation (i) mortar strength M12	Designation (ii) mortar strength M6	Designation (iii) Mortar strength M4
1 part cement 1/4 part lime 3 parts sand	1 part cement 1/2 part lime 4 1/2 parts sand	1 part cement 1 part lime 6 parts sand
✓	✓	✗

## Movement joints

- Use the mortar designations indicated on the drawings.
- Fully fill all bed and perpend joints and lay frogged bricks with frog uppermost.
- Joint profile must be bucket handle or weather-struck; both well compressed and smoothed.
- Recessed joints are not recommended in any application subjected to severe weather exposure.
- Use sulfate resisting cement when ground conditions dictate or where the risk of salt spray is present.
- Incorrect batching and mixing could ruin brickwork so extreme care must be taken when mixing on site.

# Movement Joints

## Movement joints

- In boundary walling movement joints must be provided at a maximum of 6m centres with a maximum 3m from a corner or change of direction. Where there is a short return (less than 675mm) a joint should be provided in the return.
- Joints must commence at concrete foundation level and continue through the coping/capping courses.
- A 10mm joint width will normally be sufficient. Use ties fitted with de-bonding sleeves to span the joint and maintain stability.

## Fillers and Sealants

- Filler material should be compressible by easy pressure between finger and thumb and should recoil back to its original thickness when released. Cellular polyethylene and cellular polyurethane are ideal.
- Impregnated fibre boards should not be used with clay brick as they do not compress easily and will restrict expansion.
- The filler material should be installed as the brickwork is built, keeping it back from the face of brickwork by 10mm to allow for a 10 x 10mm recess for the sealant.
- The sealant should be a polysulfide or low modulus silicone.

## Typical Movement Joint Detail Plan

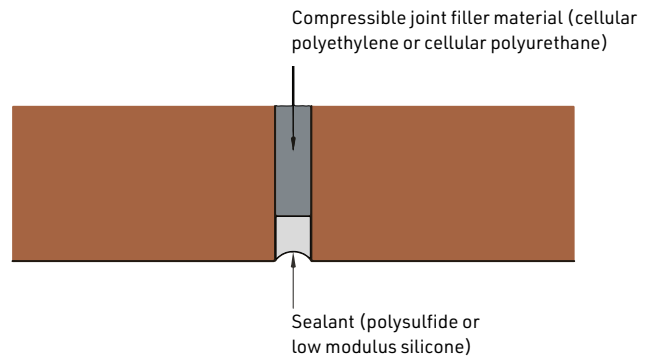

## Movement Joint Elevation

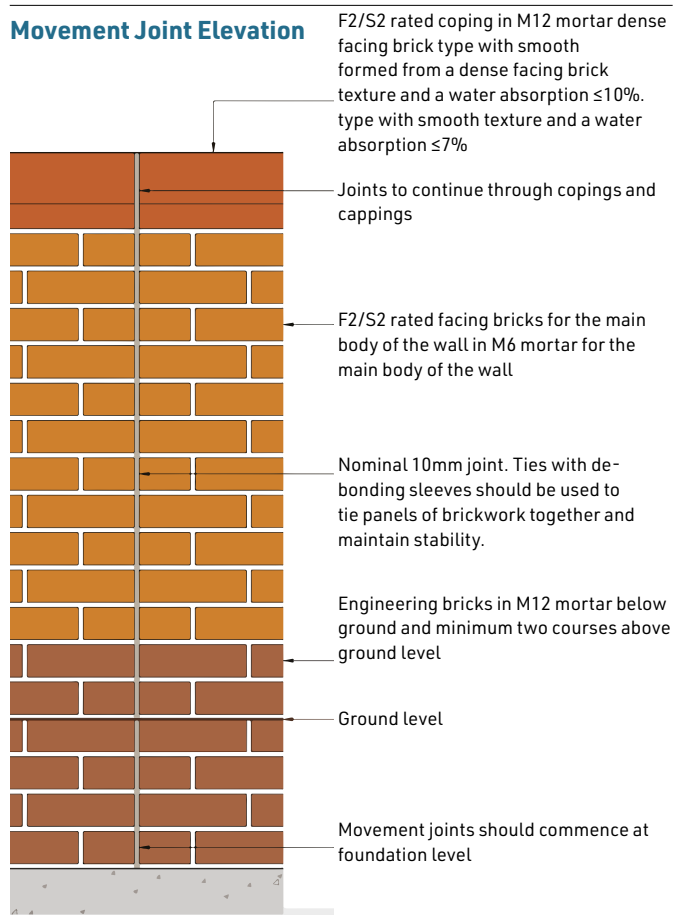

## Plan of Recommended Movement Joint Locations in Freestanding and Retaining Walls

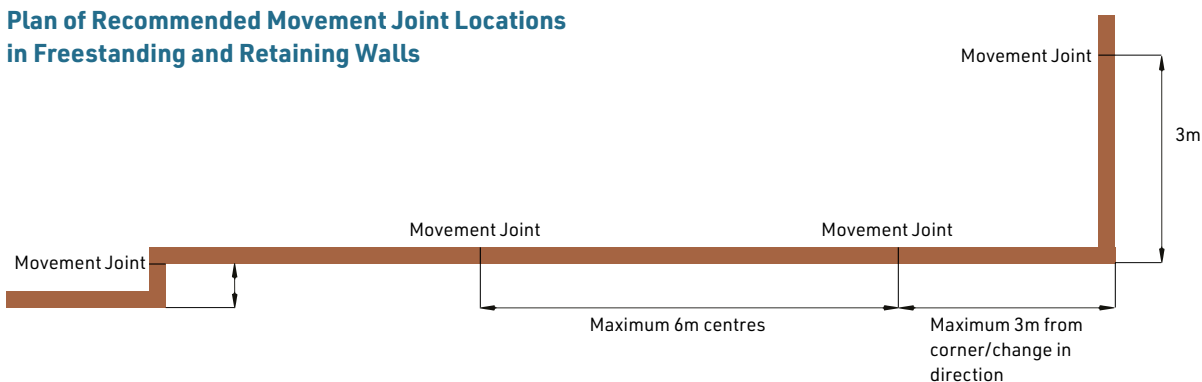

# Simple Freestanding Walls

## Clay Bricks

- All clay bricks, from concrete footings upwards, should be type F2, S2 (frost resistant, low soluble salts) or engineering A or B.
- Wall width must be a minimum 215mm, half brick thick walls are not suitable.
- Brick on edge cappings do not offer as much protection to the wall below as projecting copings but can be satisfactory where they are built using dense F2, S2 units such as engineering bricks in a designation (i) mortar and are provided with a fully sandwiched DPC or double tile creasing below.
- Water must not be allowed to pool on brick on edge applications.
- A minimum of the first 2 visible courses above ground level should be built using engineering bricks as these help inhibit rising damp and offer excellent splash zone performance.
- Copings in clay masonry must be type F2, S2 (frost resistant, low soluble salts or engineering). Copings are also available in stone, reconstituted stone and concrete.

## Damp Proofing

Water will migrate through jointed material (the mortar joints between the coping and capping units) regardless of whether they are manufactured from clay, concrete or stone.

Creasing tiles are not always an effective DPC therefore the passage of rainwater must be halted by the incorporation of damp proof material.

- At low level use a minimum of 2 courses (150mm) of engineering bricks of F2 durability in mortar designation (i) or M12 to resist rising damp.
- At the head of the wall, always use a flexible damp proof membrane beneath coping and capping courses which must be at least the width of the wall, be sandwiched within the mortar ideally projecting 5mm and have the ability to adhere to the mortar. Use a high-bond bitumen polymer type DPC.

## Freestanding Garden Wall - up to 1.2m in height

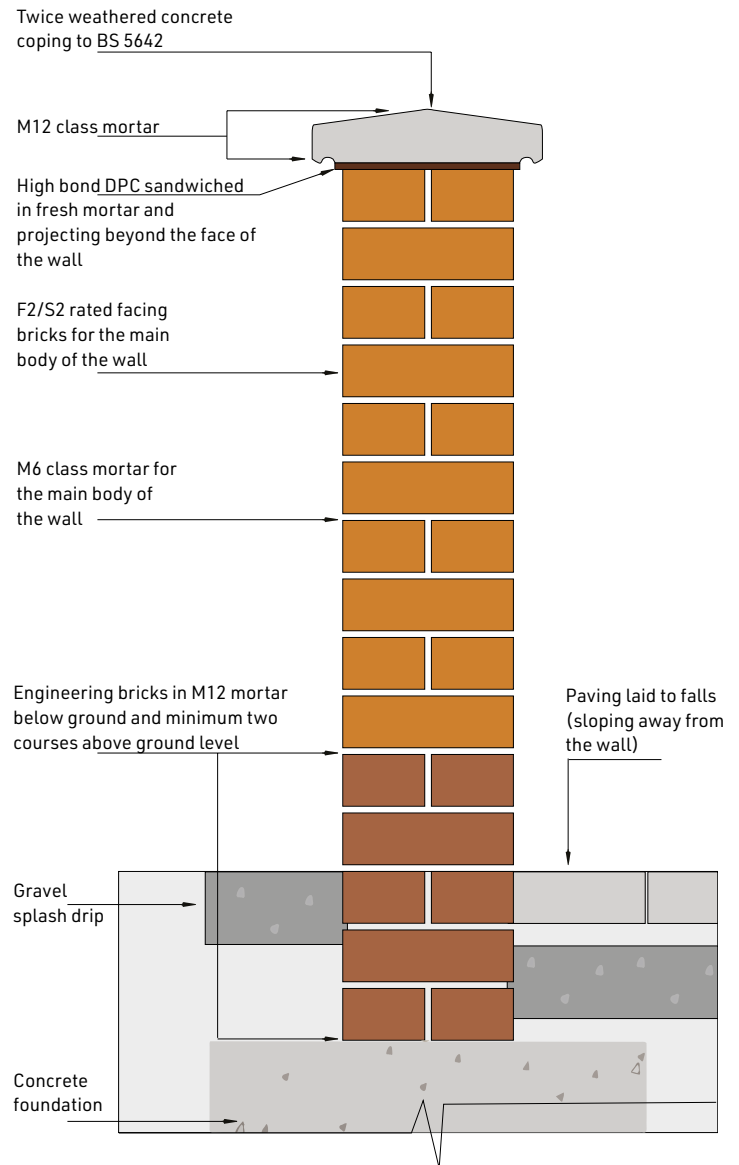

- Polyethylene DPC's should be avoided as they do not bond with the mortar leaving the coping or capping susceptible to displacement.
- Provide gravel drainage strips at ground level where possible and always ensure that any adjacent paving slopes away from the wall.
- The application of waterproof coatings, paint or other agents on the face is not recommended as they are likely to interfere with the breathability of the brickwork (waterproof layers behind retaining walls are required - see retaining walls section, pages 8-10).



# Simple Freestanding Walls

## Copings

If not properly constructed, water will ingress the brickwork structure via the mortar joints in this course compromising the long-term durability of the wall beneath. Projecting copings (min 40mm projections to throw water clear of the brickwork below) with a drip groove (throating) are strongly preferable to flush cappings.

Clay brick copings must always be dense, preferably smooth F2, S2 (frost resistant, low soluble salts), or engineers with an overhang and drip groove for the ability to shed water.

Copings are also available in stone, reconstituted stone and concrete and their manufacturers advice should be sought.

## Creasing Tiles

If not using an overhanging coping, a minimum of 2 40 staggered courses of creasing tiles should be incorporated under the capping unit, ensuring an overhang of at least 40mm each side to direct water away from the wall. As the material is jointed a flexible high-bond DPC should be placed between or beneath the tiles to prevent moisture tracking through the mortar joints.

## Copings to Pillars

One piece units are recommended to shed the water and should incorporate an overhang and a drip groove (throating).

## Mortar joint Profiles

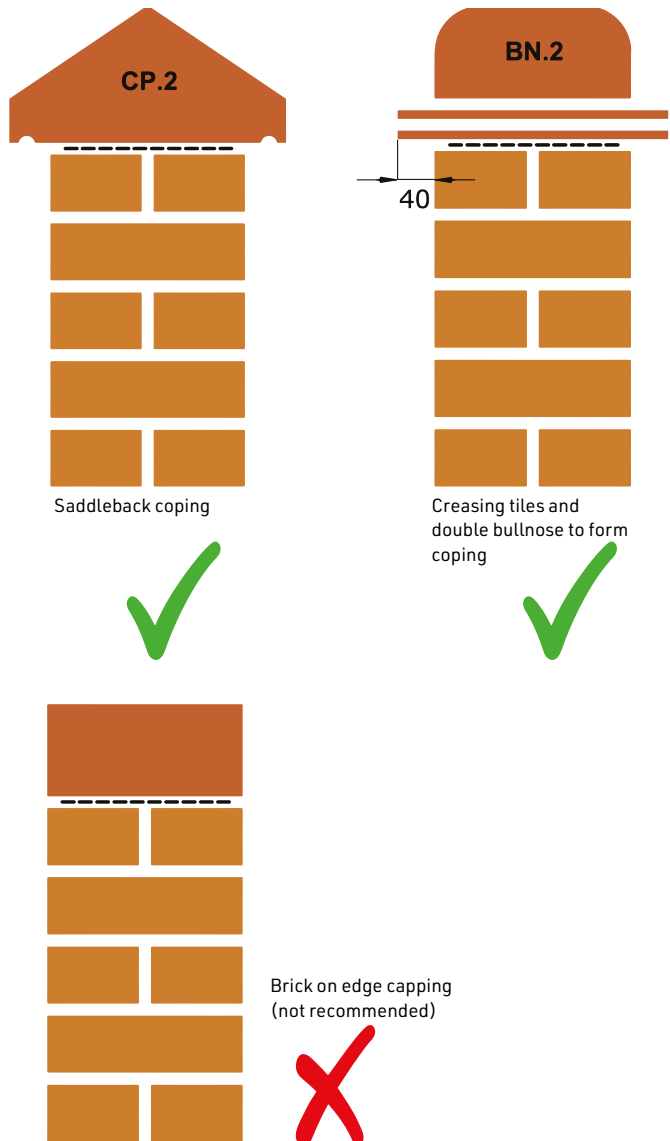

## Summary of Do's and Don'ts when constructing freestanding walls

### Do's

- Select appropriate bricks and make the wall at least 215mm wide.
- Copings are better than cappings.
- Use a high-bond DPC below the capping/coping and sandwich the DPC in mortar.
- Incorporate an engineering brick DPC at the base.
- Use the correct mortar mix.
- Use bucket handle or weather-struck mortar jointing.
- Design for and build-in movement joints.
- Slope paving away from the wall.
- Provide gravel drainage strips where possible.



### Don'ts

- Use recessed mortar jointing.
- Use coatings or waterproofing agents.
- Build higher than 1m without involving a structural engineer.



# Simple Retaining Walls

This guide deals with walls where differing ground levels and loadings are minimal. Where level differences are substantial or other buildings will be close by, professional guidance should be obtained from a Structural engineer or the local Building Control Officer.

## Height and Thickness

A minimum wall thickness should be 215mm of bonded construction or two separate brick skins tied together (see reinforcement, page 10). This will suffice in most cases where the ground level difference does not exceed one metre and where ground and water pressures are minimal.

## Clay Bricks

■ All clay bricks should be F2 (frost resistant quality) and S2 (limited soluble salts) or engineering A or B designation.

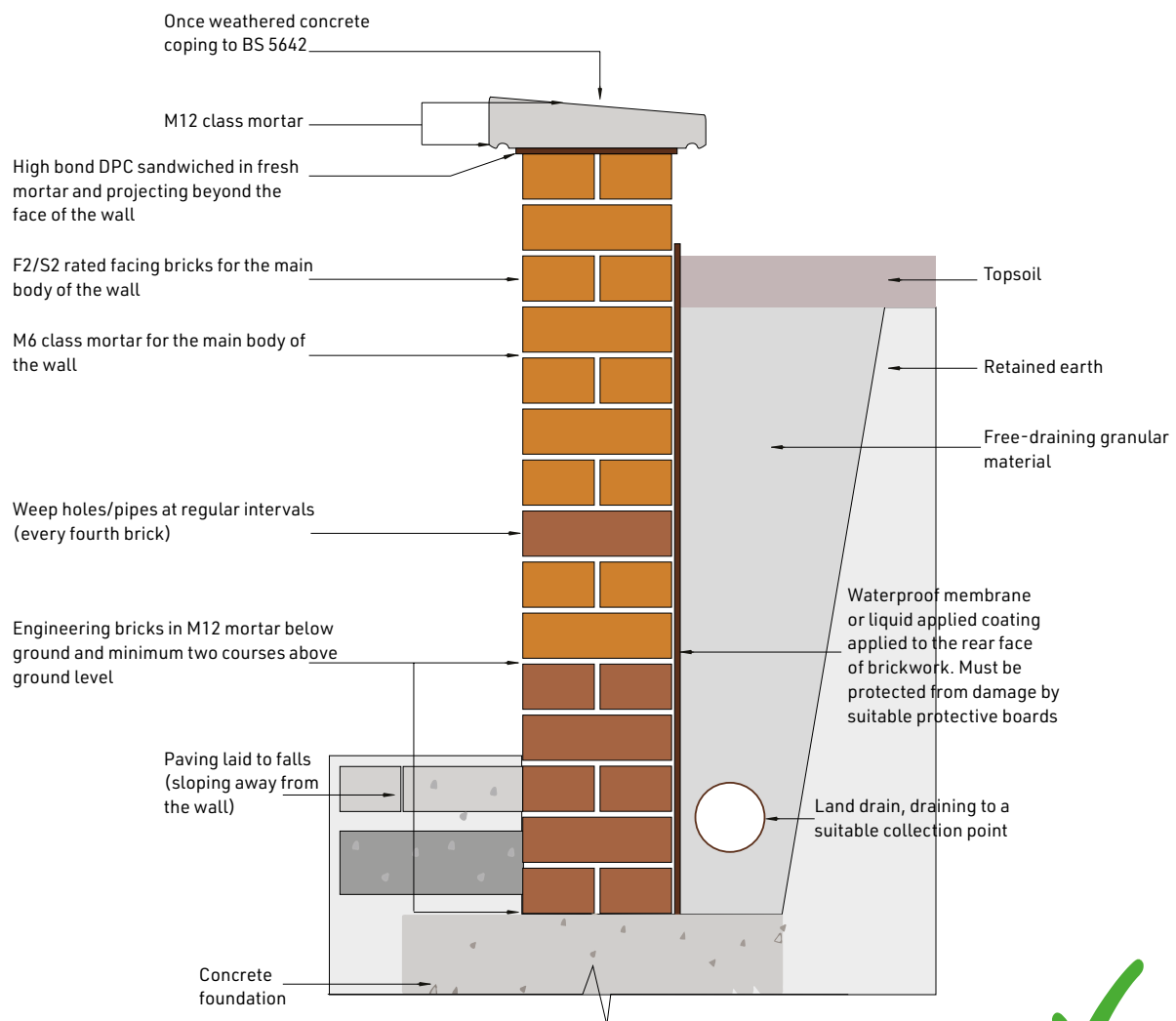

# Simple Retaining Walls

## Retaining Wall - Incorrect Application

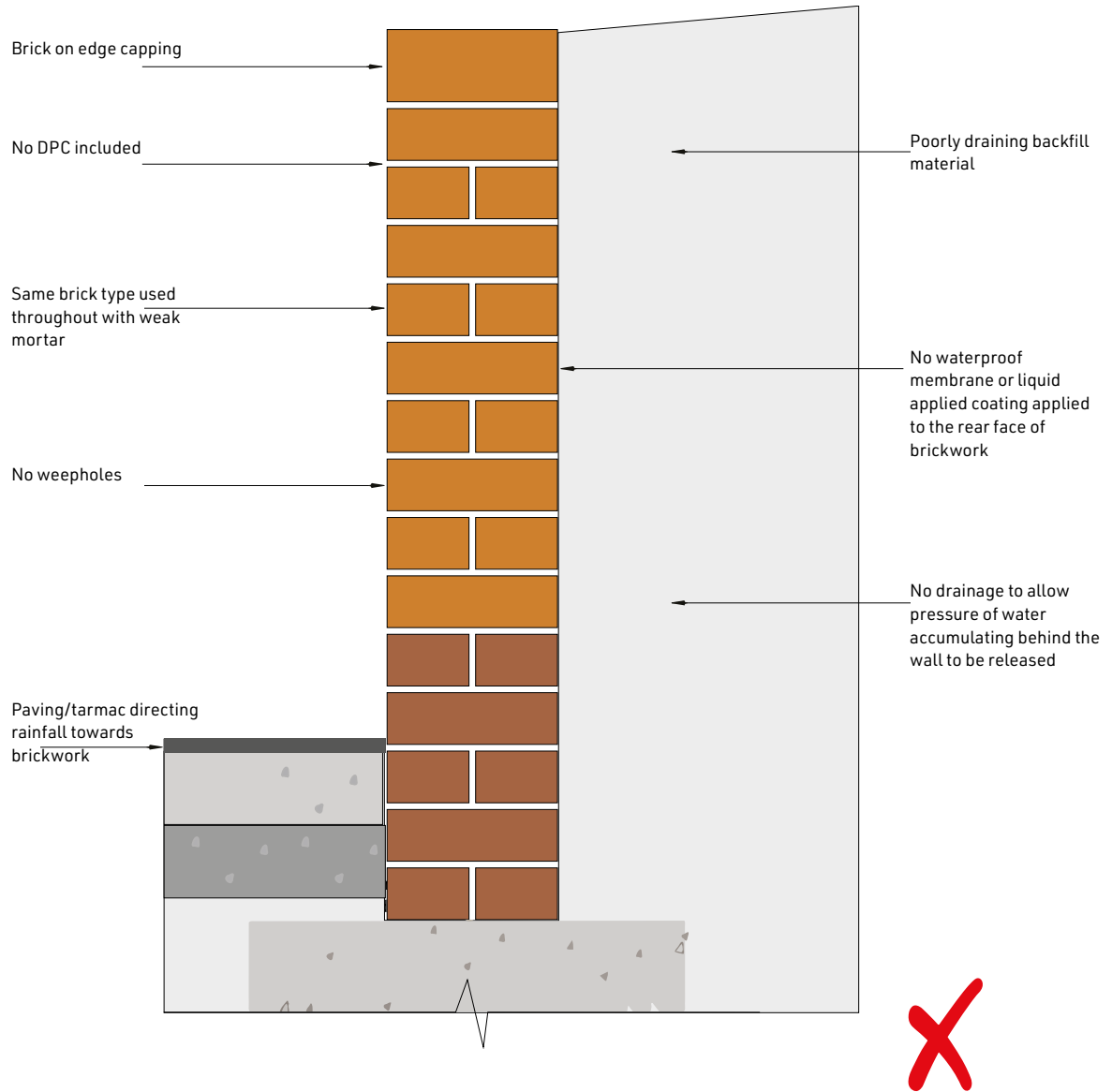

# Simple Retaining Walls

## Damp Proof Courses and Waterproofing

- For greater stability use a minimum 2 courses (150mm) DPC grade 1 or 2 or engineering bricks at ground level.
- Always use a DPC beneath coping courses which must be at least the width of the wall, be sandwiched within the mortar and have the ability to adhere to it (high-bond).
- For continued durability the faces of retaining brickwork in contact with all retained material must be protected with a minimum 2 coats of proprietary liquid waterproofer or self-adhesive membrane. The layer should then be protected by boards and a layer of free-draining gravel.
- Walls should project sufficiently above ground level to allow waterproofing to be effective and earth should not bear down directly onto the coping course.

## Drainage

ground water can exert considerable pressure and saturate the brickwork. Water accumulating behind retaining walls and exerting pressure, must be released. A gravel trench and 38 or 50mm plastic pipes through the wall will normally suffice.

*Note: Leaving open perpend joints to release collected water can lead to localised wall saturation, with resultant staining and potentially an effect on durability.*

## Summary of Do's and Don'ts when constructing freestanding walls

### Do's

- Select appropriate bricks and make the wall at least 215mm wide.
- Use a high-bond DPC below the capping/coping and sandwich the DPC in mortar.
- Waterproof the retaining side.
- Use the correct mortar mix.
- Design and build-in movement joints.
- Use bucket handle or weather-struck mortar jointing.
- Allow water to drain away from the retaining side via weep holes/pipes.
- Slope paving away from the wall.
- Provide gravel drainage strips where possible.



### Don'ts

- Use recessed mortar jointing.
- Rely on "free-draining" fill materials provide positive drainage measures.
- Forget to protect waterproofing from damage.
- Build higher than one metre without involving a Structural engineer.



## Movement Joints

Movement joints must be provided as previously outlined. To increase stability at the movement joint position, piers can be built at either side.

## Copings

- Clay brick copings must always be F2, S2 (frost resistant low soluble salts) or engineering, with an overhang and drip groove for the ability to shed water.

Concrete or stone are also available materials.

## Reinforcement - bed-joint type

- Where the wall is constructed of two separate brick skins in stretcher bond, they will require tying together.
- Stainless steel bed-joint reinforcement every third course will achieve this and greatly enhance the strength.

# Chimney Construction

Because chimney stacks are normally exposed on all four faces and the top, they may be more liable to saturation and frost attack than other parts of the building, especially where an effective coping has not been provided at the terminal.

horizontal surfaces can become saturated or nearly saturated and are readily frozen by night frosts which are common in all parts of the UK. extra care should be given to the choice of masonry if the building is to be located in conditions of severe or very severe exposure

## Bricks used in the stack

- Select bricks of F2 (frost resistant) and S2 (low active soluble salt content) or engineering for durability.
- Consider projecting details and the likelihood of water pooling on projecting brickwork ledges.

## Mortar

- use a designation (i) or M12 for exposed detailing. The exception to this recommendation would apply to 'stock' bricks for which designation (ii) or M6 should be used.
- Consider sulfate resistant cement where "real fires" are involved.
- Fully fill all bed and perpend joints and lay frogged bricks with frog uppermost.
- Joint profiles must be bucket handle or weather-struck; both well compressed and smoothed.
- Using mortar of insufficient strength will compromise the overall durability of the chimney. Such mortar will over time become very soft and organic growth can take hold and exacerbate the problem if an insufficient amount of cement is used.
- recessed joints are not recommended in any application subjected to severe weather exposure.

## Mortar joint Profiles

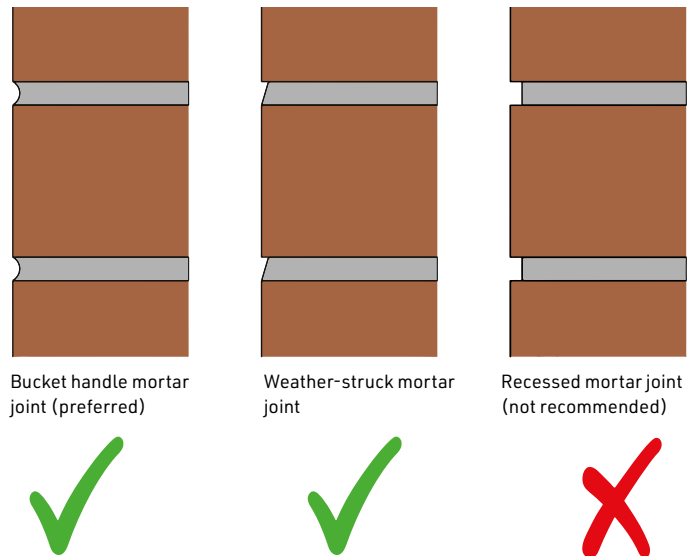

Bucket handle mortar joint (preferred)

Weather-struck mortar joint

Recessed mortar joint (not recommended)

## Copings/Cappings

- Chimney terminals must be provided with an overhanging coping.
- Drip edges should be positioned a minimum 40mm from the face of the wall.
- Brick on edge or brick on bed cappings are not recommended, nor mortar flaunching which will deteriorate rapidly in severe exposure areas.
- Copings and terminal units must be provided with a continuous DPC.

# Chimney Construction

## Option 1 (Preferred)

## Option 2

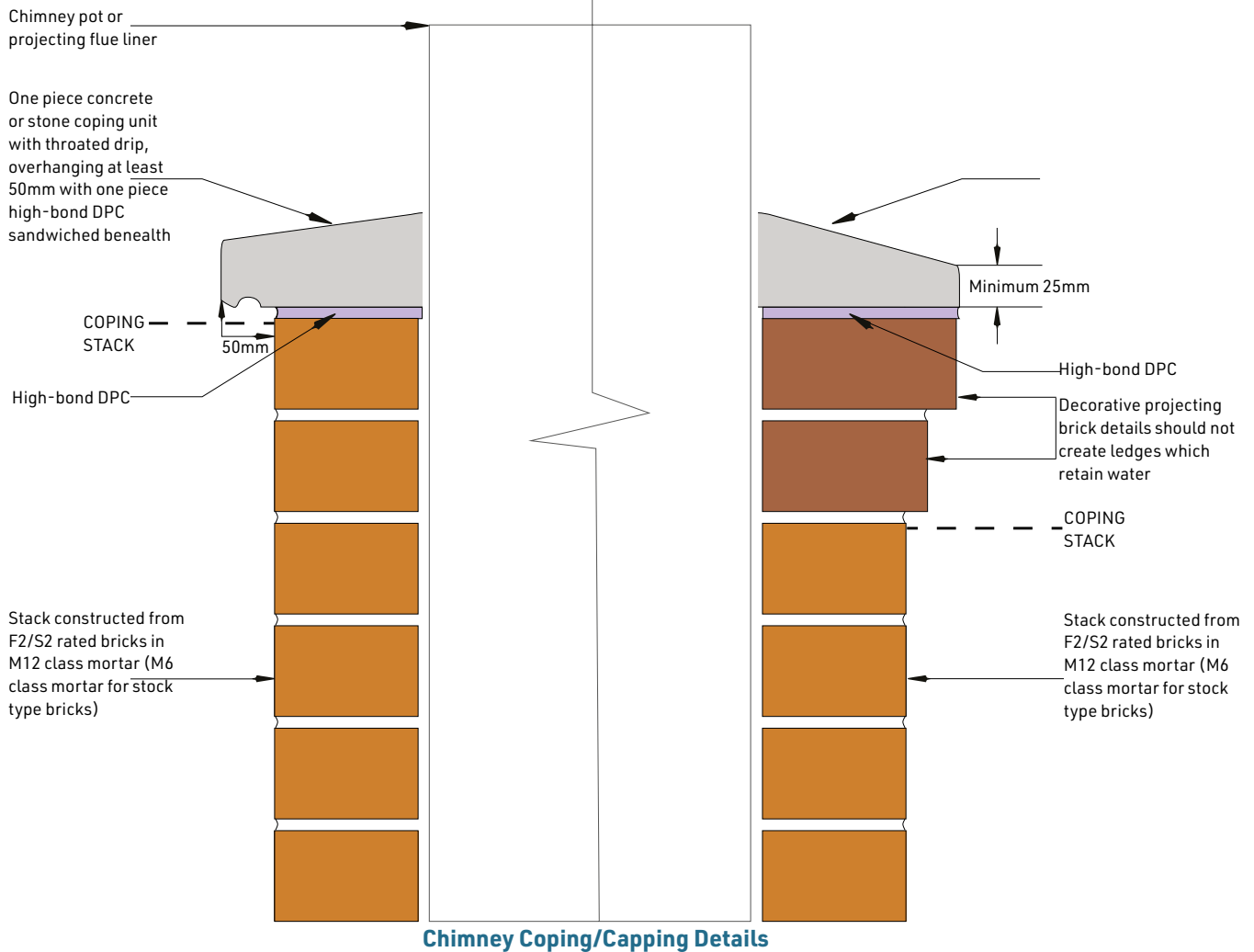

*Note: Where there is a risk that flue gases may affect masonry sulfate resisting cement should be used*

## Summary of Do's and Don'ts when constructing chimneys

### Do's

- Use a one piece overhanging coping unit with a DPC and drip groove.
- Use the correct mortar mix.
- Use bucket handle mortar jointing.
- Check with manufacturer on suitable brick products for the stack.



### Don'ts

- Use recessed mortar jointing.
- Use mortar flaunching to cap the chimney.
- Use brick on edge cappings.





# Window Cills

## Window Cills

- Consider using concrete or stone units or proprietary brick specials with an overhang and drip groove.
- Brick on edge is not recommended but if specified select only engineering or specific brick units as advised by the manufacturer.
- Set in a class (i) or M12 mortar with a tooled bucket handle joint finish.

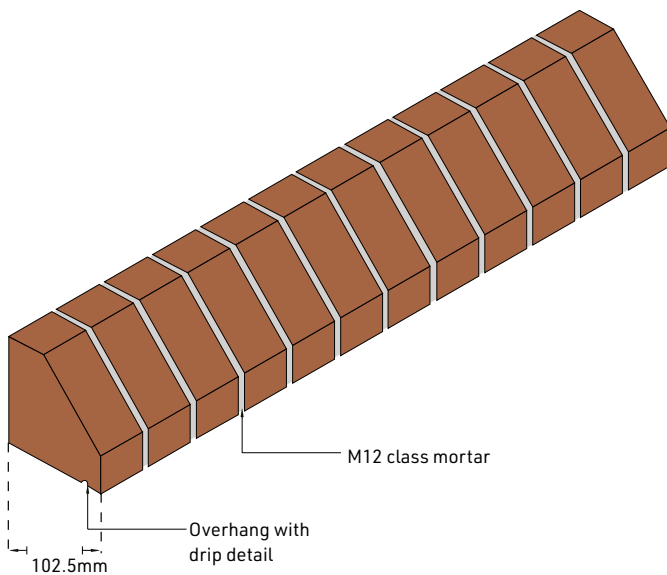

**Window Cill Formed from Proprietary Brick Specials**  
(Alternative sizes/shapes available)

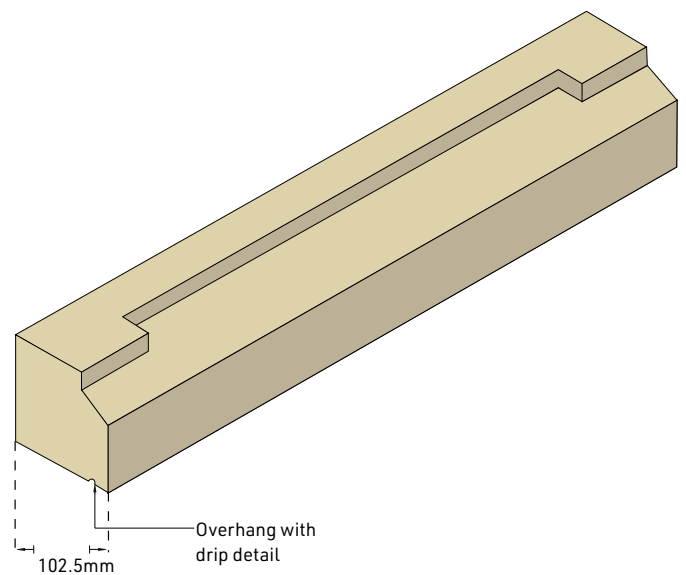

**Stone Cill**

# Step Flank Walls

## Step Flank Walls

- Bricks to BS EN 771-1 are not intended to be used as step risers or treads. Proprietary paving units for this application must be incorporated.
- Flank walls supporting steps must be designed carefully to avoid continued saturation of the brickwork.

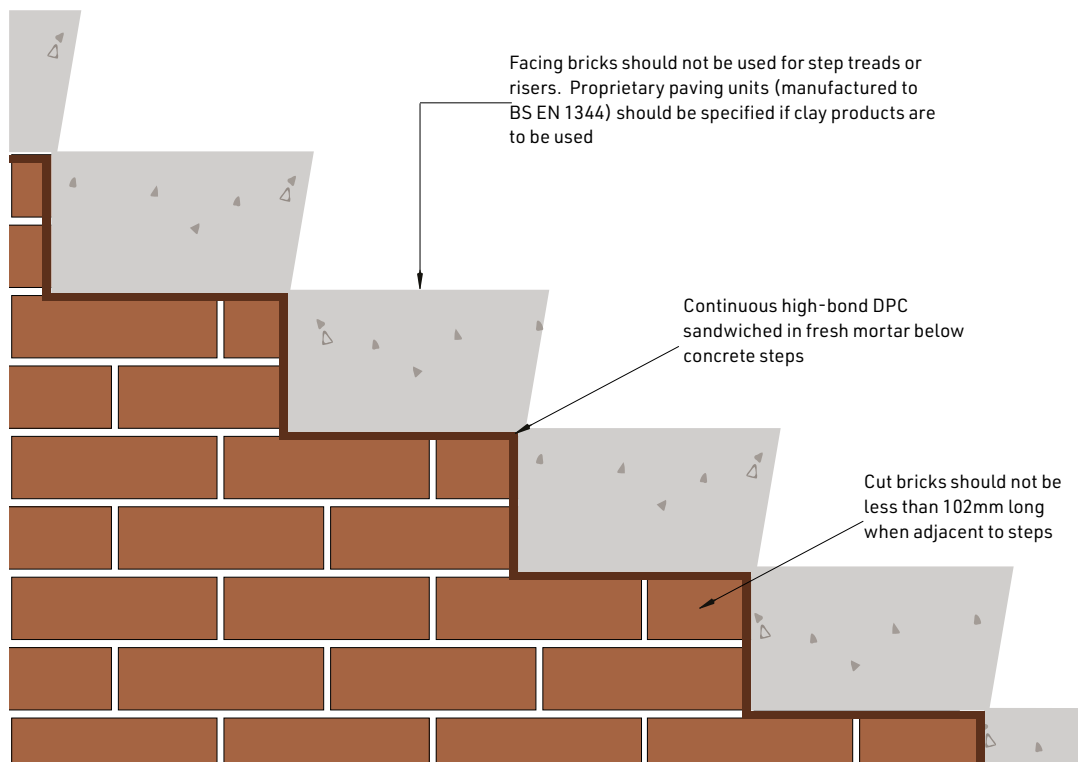

## Step Flank Walls

Elevation

# Step Flank Walls

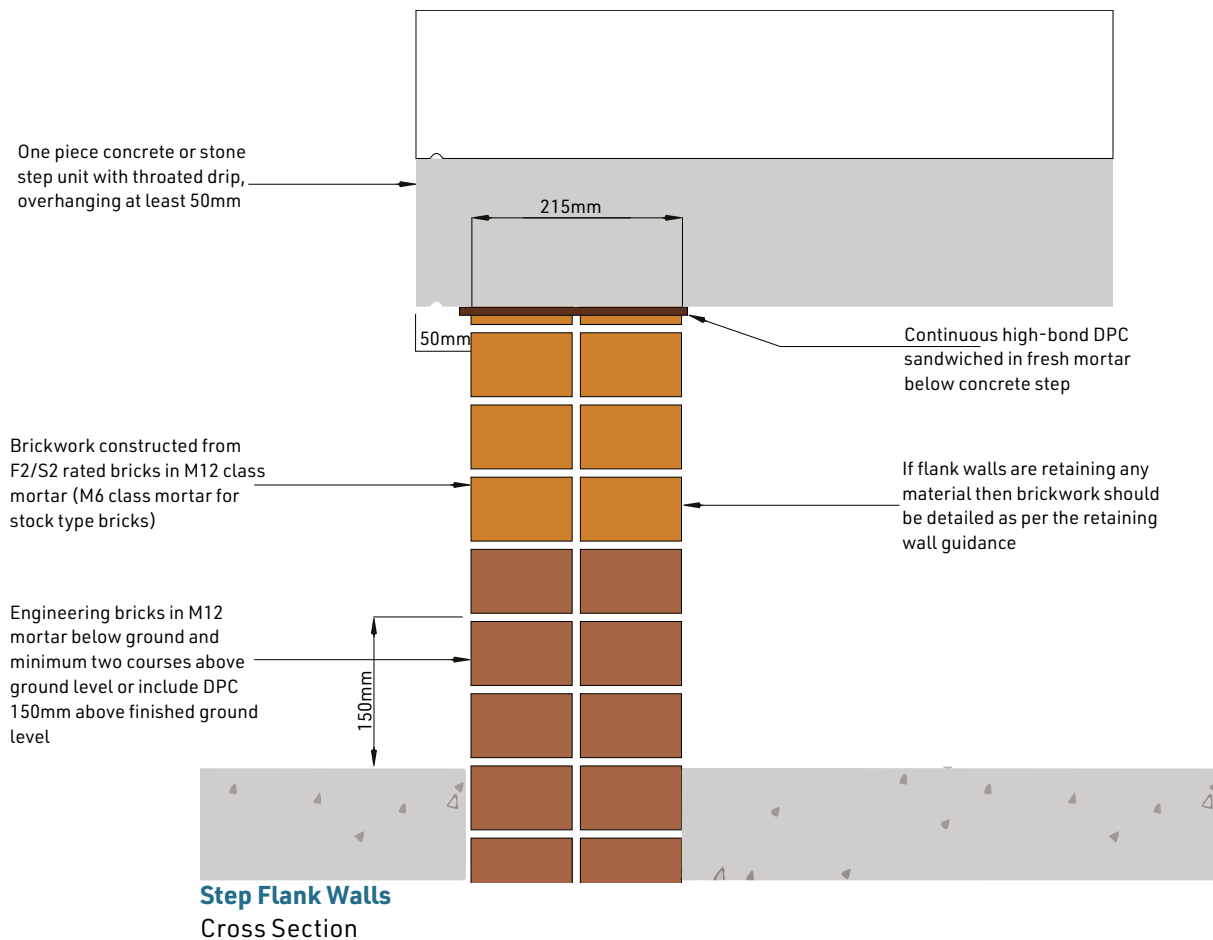

## Summary of Do's and Don'ts when constructing step-flank walls and steps

### Do's

- Place a high-bond DPC on flank brickwork below the step and sandwich the DPC in mortar.
- Use the correct mortar mix.
- Use bucket handle mortar jointing.
- Use proprietary paving units.



### Don'ts

- Use recessed mortar jointing.
- Use coatings or waterproofing agents other than where indicated.
- Use standard bricks as treads or risers.



*The BDA accepts no responsibility for any miscommunication of construction details for your built project, this information must be confirmed by a qualified and competent designer as suitable for the purpose intended before any works are undertaken.*

*This document can be downloaded via the BDA website under 'Technical Guides'.*

---

# Brick Development Products & Services

---

## Brick Awards

The Brick Awards celebrate the best examples of clay brick in our built environment. Each year the awards attract over 350 entries from leading architects, housebuilders, developers and contractors; across 17 hotly contested categories. It is FREE and simple to enter on our web site: [www.brick.org.uk](http://www.brick.org.uk)

---

## Technical Publications

The BDA provides a range of technical publications and guides; which are freely available to Architects, Developers, Builders and General public on our web site: [www.brick.org.uk](http://www.brick.org.uk)

The Fourth Edition of 'Guide to Successful Brickwork' is available at all good book shops.

---

## Brick Works Events

The BDA regularly runs courses and seminars for all those professionals involved with the design and construction of brick buildings. Please contact George Spreckley our Events & PR Manager on email: [georgespreckley@brick.org.uk](mailto:georgespreckley@brick.org.uk)

---

## Brick Bulletin

This widely acclaimed e-magazine features the latest developments in brick design and is recognised world wide as the foremost journal of contemporary brickwork. It is available free through the 'Brick Bulletin' tab our website: [www.brick.org.uk](http://www.brick.org.uk).

---

## Brickmakers Quality Charter

Clay brick makes a significant contribution to the UK's safe, healthy and sustainable built environment. The Brickmakers Quality Charter scheme promotes the responsible sourcing of clay brick, through credentialling and the flexibility businesses seek from an established and audited supply chain.

---

## Training and Education

The BDA offers lectures and other educational services for Architects, Engineers, Developers as well as support for students and public interested in creating successful brickwork. We also provide technical input to events for practicing architects, engineers and organisations involved in continuing professional development.

---

## Research and Testing

The BDA identifies specific areas where independent research and testing programmes are required to further the confident use of clay brick and to ensure quality.

---

## Statistical and Marketing Information

The Brick Development Association is an independent body committed to providing authoritative information about the use of clay brick in construction.

We collate statistical information on brick production, UK deliveries, and related supply for imported products together with volume information including testing, research and development.

We provide free technical support on the use of clay brick, and encourage best practice in the use of brick in the built environment.





Published by the Brick Development Association.(BDA).

The BDA are committed to providing impartial and authoritative information. We make every effort to ensure the accuracy and quality of information and guidance when it is published. However we can take no responsibility for the subsequent use of this information, nor for any errors or omissions it may contain.

**The Brick Development Association**  
1st Floor,  
31 Worship Street,  
London,  
EC2A 2DY

020 7323 7034  
[brick@brick.org.uk](mailto:brick@brick.org.uk)  
[www.brick.org.uk](http://www.brick.org.uk)

